

取扱説明書 Operation Manual

モデル Model: SC-UE15R

名称 Name: FPSC モジュール UE15R 吸熱リング付
FPSC Module UE15R with Thermal Conductor

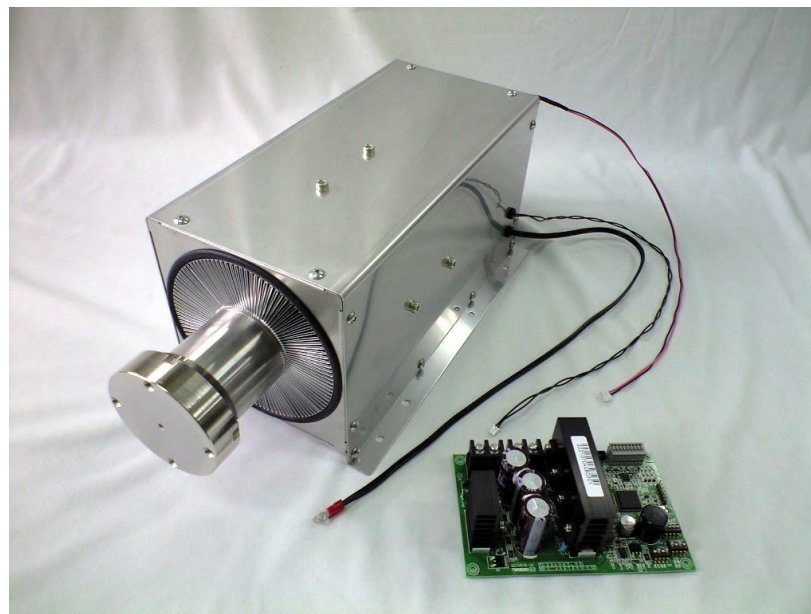

ツインバード工業株式会社
TWINBIRD CORPORATION



1. 輸出規制について

スターリング冷凍機は以下の日本の輸出規制が適用されます。
日本から輸出される場合は、経済産業大臣の許可が必要となります。

また、輸出先から再輸出する際は、その国の輸出規制に従って下さい。

該当項目:「光検出器の冷却器」

<貨物>

輸出令別表1:10項(2)号

貨物等省令:第9条1項六号ロ(一)

もし、輸出を希望する場合は、事前に弊社SC営業部にお問い合わせください。
なお、この適用は2019年11月現在であり、法令は改正されることがあります。

1. Restriction of Export

The following regulations shall apply to Stirling Cooler and permission for export by the Ministry of Economy, Trade and Industry is required before exporting Stirling coolers from Japan for abroad.

- Foreign Exchange and Foreign Trade Law-section 1 of article 48.
- Foreign Exchange and Foreign Trade Law-section 1 of article 67.
- Export Trade Control Ordinance-section 2 of article 8.

If you wish to export our Products from Japan for abroad, please contact us prior to exporting.

The above regulations were applied at the time of November 2019. Laws and regulations may be revised according to the legal revisions.



2. 警告及び注意

- (1) FPSC モジュール (Free Piston Stirling Cooler Module) は DC48V 専用です。DC12V、24V あるいは AC100~240V 等、他の電圧では使用しないでください。故障の原因となります。
- (2) 0~40°C の環境でご使用ください。これ以外ですと、故障の原因となります。
- (3) 吸熱部の許容温度範囲は -120~+70°C です。冷えすぎないように吸熱量を調節してください。また、ヒーターなどで加熱しないで下さい。故障の原因となります。
- (4) 放熱フィンが埃等により目詰まりしないようにご使用ください。
- (5) 放熱フィンをお取り扱いの際は事故やけがにご注意ください。また、放熱フィンの変形、破損にご注意ください。
- (6) FPSC モジュールから異音が発生したときは、出力設定電圧を調整して FPSC への出力を抑えてください。
それでも異音が発生する場合は、弊社までお問い合わせください。
- (7) FPSC モジュールに強い衝撃を与えないで下さい。故障の原因となります。
- (8) FPSC モジュールや基板に水等の液体をかけないでください。故障の原因となります。
- (9) 酸、アルカリ等の腐食性のガス及び液体、有害なガス雰囲気中及び有害なガスを発生する物質のないところでご使用ください。錆が発生したり、寿命が短くなったりする場合があります。

2. Warning and Caution

- (1) The Free Piston Stirling Cooler Module (FPSC Module) must be used with a 48 V DC power source. Internal damage can result from operating this FPSC Module directly with any input voltage other than 48 V DC.
- (2) The FPSC Module is designed for use in ambient temperatures between 0 - 40 deg. C.
Internal damage could result from operating the FPSC Module outside this temperature range.
- (3) The cold side of the FPSC Module should be maintained between -120 and +70 deg. C. Operation outside of this temperature range could result in internal damage to the FPSC Module. To avoid the possibility of damaging to internal parts by overheating the FPSC Module, do not apply heating elements directly to the cold side.
- (4) Use caution to prevent the Heat Reject Fin from being filled by dust.
- (5) Use caution when handling the Heat Reject Fin assembly to prevent damage or injury. Inspect the Heat Reject Fin assembly for deformity or breakage before use.
- (6) Reduce the output setting of the FPSC Module if unusual noises are observed coming from inside the pressure vessel.
Please contact Twinbird if the reduced output setting does not eliminate the unusual noises.
- (7) Avoid subjecting the FPSC Module to excessive shock. It could cause internal damage.
- (8) Direct exposure of the FPSC Module and PCB to water or other liquid could cause electrical failure.
- (9) Do not use the FPSC Module and the drive PCB in acidic, reactive gases or around places that reactive gases are made. Rust or other corrosion may damage them integrity and shorten the life span.



- (10) FPSC モジュールや基板をストーブや火気の近くに近づけないで下さい。故障の原因となります。
- (11) FPSC モジュールを火の中に放り込まないで下さい。内部のガスが膨張し、爆発する恐れがあります。
- (12) コードを強く引っ張らないで下さい。断線し、故障の原因となります。
- (13) FPSC モジュールの分解は絶対に行わないでください。
- (14) FPSC モジュールの放熱フィンや基板の部品は、運転中及び停止直後は高温になっていることがあります。素手で触らないでください。火傷の恐れがあります。
- (15) FPSC モジュールの吸熱部及びその周辺は、運転中及び停止直後は低温になっています。素手で触らないでください。凍傷の恐れがあります。
- (16) FPSC モジュールの吸熱部及びその周辺は、霜や露がつかないように断熱してください。また、単体での動作確認などで霜や露が付着した場合は、運転を停止させた後にやわらかい布などでふき取ってください。着霜や結露は冷却能力の低下につながり、融けた霜や露が電源コードや内部の機構部品に流れ落ちると、電気回路がショートして故障したり、腐食の原因になったりしますので、十分ご注意ください。
- (17) FPSC モジュールの吸熱部は薄いステンレス板で形成されており、内部は精密構造になっておりますので、熱交換器の取り付けの際など、吸熱部に強い力を加えないで下さい。故障の原因となります。
- (18) 廃棄の際は、スターリングクーラー本体をケースより取り出し 1/4 インチ パージングバルブを用いて、銅パイプから内部のガスを抜いた後、各国ルールに沿って廃棄してください。作業は安全手袋を用い、開放空間にて作業をしてください。
- (10) Direct exposure of the FPSC Module and PCB to fire or excessive heat could cause internal damage.
- (11) Warning: Placing the FPSC Module into fire or excessive heat could cause expansion of the contained gas and explosion.
- (12) Do not put excessive strain on the electrical cords. It could cause damage to the wire and cause the FPSC Module stop operating.
- (13) Do not disassemble the FPSC Module.
- (14) To avoid the danger of burns, avoid touching the heat reject fin and certain parts on PCB with your bare hands during or immediately after operation.
- (15) To avoid the danger of frostbite, avoid touching the cold side and its immediate surroundings with your bare hands during or immediately after operation.
- (16) Please provide thermal insulation around cold side to prevent frost and dew condensation. If conditions require that you need to operate the FPSC Module without thermal insulation, the cold side may develop a coating frost or water. If this occurs, please clean the cold side with a soft cloth. Having frost or condensation on the cold side surface can cause an apparent reduction of cooling capacity. Also, if water drips down on a power cord or inner mechanical parts as it defrosts, it could cause a short circuit or corrosion.
- (17) Failure of the FPSC Module could result from subjecting the cold side to a strong force. It is made of thin stainless steel sheet surrounding a precision structure.
- (18) When you intend to scrap the Stirling cooler, disassemble the Stirling cooler from casing, discharge internal gas from the copper pipe by using 1/4 inch purging valve and then treat based on each country regulation. Also, please use safety gloves and work in the release space when disassembling and pulling the gas out.



スターリングクーラー本体
Stirling cooler

銅パイプ
Copper pipe



(19) 駆動基板は電源の逆接続対策仕様で故障しにくくなっておりますが、静電気やショート等に注意してお取り扱いください。

- (A) 使わないときは、導電袋に入れておいて下さい。
- (B) 基板を取り扱う際は、手首からアースを取る等、人体から静電気を放電することをお勧めします。
- (C) 裏面が金属に触れるとショートして電子部品が破損します。
電源が切れていても静電気等で故障する場合があります。
表面同様に裏面にも電子部品がついておりますので、ご注意ください。

(20) 本製品の仕様を満足する範囲において、性能向上のため、部品など一部を連絡なしに変更する場合があります。

(21) 完成機器における規格、法令等の適合性については貴社にてご確認願います。

(19) Although the drive PCB is protected against reverse connection, use caution to prevent static electricity or short circuit.

- (A) Keep the PCB in the static shielding bag before use.
- (B) Discharge static electricity from your body using wrist straps, etc.
- (C) Electric parts may be damaged by the short circuit when the backside of the PCB touches some metal parts.
It may be damaged by static electricity.
Use caution to prevent damage of backside electric parts.

(20) In order to improve the performance, the FPSC and associated parts may be changed within the scope of the specification without any consultation or advice.

(21) Please ensure that local laws or standards are met for final products that are equipped with this FPSC Module.

3. 仕様 Specification

3.1 外観 Exterior

[FPSC モジュール FPSC Module]

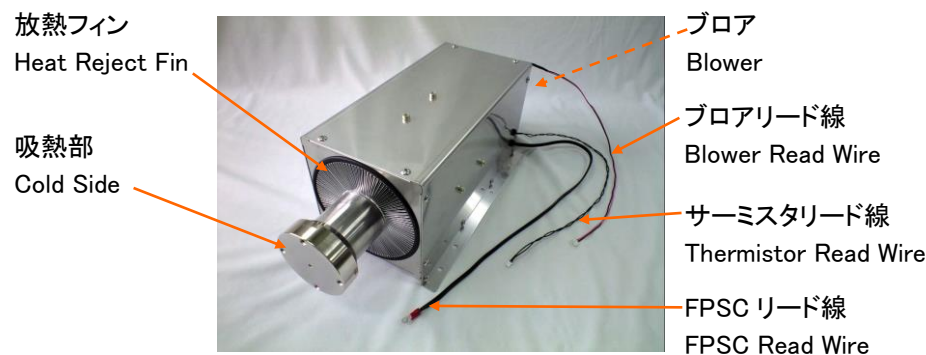

[駆動基板 Drive PCB]

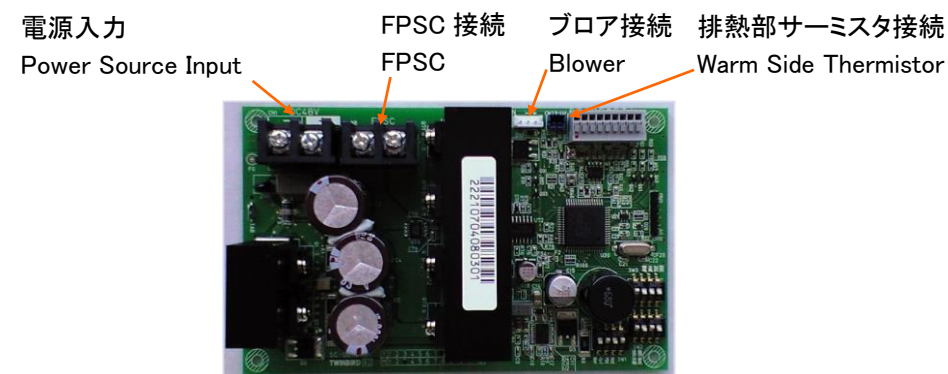

3.3 主な仕様

No.	項目	仕様	
1	製品寸法	W 180 x H 160 x D 431 mm	
2	製品質量	約 9 kg	
3	冷媒	ヘリウム	
4	冷媒量	約 3 g	
5	冷媒圧力	2.2 MPa (20°C)	
6	電源電圧 ^{※1}	DC 48 V ±10 % (駆動基板入力)	
7	定格電流 ^{※1}	5A ピーク電流が 9A 流れる場合があるので、9A 以上の容量を持つ電源を準備してください。	
8	冷凍能力 ^{※2} [条件] 周囲温度: 25°C 出力設定: 最大	42.5W 以上 (吸熱部温度: -80°C)	
9	使用温度・湿度条件 ^{※3}	周囲温度	0 ~ +40 °C
10		吸熱部温度	-120 ~ +70 °C
11		排熱部温度	0 ~ +70 °C
12		湿度	0 ~ 90 %RH 結露なきこと
13	付属品	駆動基板	

※1 動作確認済み電源

- (1) TDK-Lambda ZWS240PAF-48/**
(トランス T1 コアの温度が 80°C 以下になるよう、必要に応じて空冷する。)
- (2) TDK-Lambda HWS300P-48
(カバー付タイプ)

※2 冷凍能力は吸熱部温度、周囲温度などによって異なります。詳細につきましてはお問い合わせください。

- ※3 (1) 吸熱部温度が 0°C を超えて使用する場合、応用製品に応じて FPSC への出力電圧を絞ってご使用ください。
- (2) 本製品を動作させたまま吸熱部温度を急激に変化させた場合、異常音が発生することがあります。応用製品に応じて異常音が発生しないようにご使用ください。

3.3 Main Specification

No.	Item	Specification	
1	Product Dimension	W 180 x H 160 x D 431 mm	
2	Weight	Approx. 9 kg	
3	Refrigerant	Helium	
4	Amount of Refrigerant	Approx. 3 g	
5	Inside Pressure of Stirling Cooler	2.2 MPa (20 deg. C)	
6	Power Source Voltage ^{*1}	DC 48 V ±10 % (for Drive PCB)	
7	Rating Current ^{*1}	5A Prepare power supply with output current more than 9A for peak current 9A.	
8	Cooling Capacity ^{*2} [Condition] Ambient Temp.: 25°C Output Setting: Max	42.5W and over (Cold Side Temp.: -80 deg. C)	
9	Operating Conditions of Temperature and Humidity ^{*3}	Ambient Temp.	0 ~ +40 deg. C
10		Cold Side Temp.	-120 ~ +70 deg. C
11		Warm Side Temp.	0 ~ +70 deg. C
12		Humidity	0 ~ 90 %RH No Dew Condensation
13	Accessories	Drive PCB	

*1 Power Supplies tested with Drive PCB

- (1) TDK-LAMBDA ZWS240PAF-48/**
(It must to keep the T1 trans core temperature lower than 80 deg. C. It may be required to use air blow cooling.)
- (2) TDK-Lambda HWS300P-48
(Covered type)

*2 Cooling capacity changes depends on the cold side temperature, ambient temperature, etc. Please contact us for more information.

- *3 (1) If you use the cold side temperature over 0 deg. C condition, please turn the FPSC voltage down accordingly the application product.
- (2) An abnormal noise may occur from the FPSC when the cold side temperature is changed suddenly. Please use accordingly the application product to prevent the abnormal noise.



4. 基本的な使い方

4.1 準備

- (1)電源: 電圧 DC48V、定格電流 5A
ピーク電流が 9A 流れる場合があるので、9A 以上の容量を持つ電源を準備してください。
- (2)温調器と温度センサー
- (3)配線材とスイッチ

4.2 起動手順

- (1)DC48V 電源のスイッチを入れる。
- (2)駆動基板に取り付けたスイッチを ON(CLOSE)にする。

4.3 停止手順

- (1)駆動基板に取り付けたスイッチを OFF(OPEN)にする。
- (2)DC48V 電源のスイッチを切る。

4.4 配線 Wiring

[電圧入力の場合 Voltage Input]

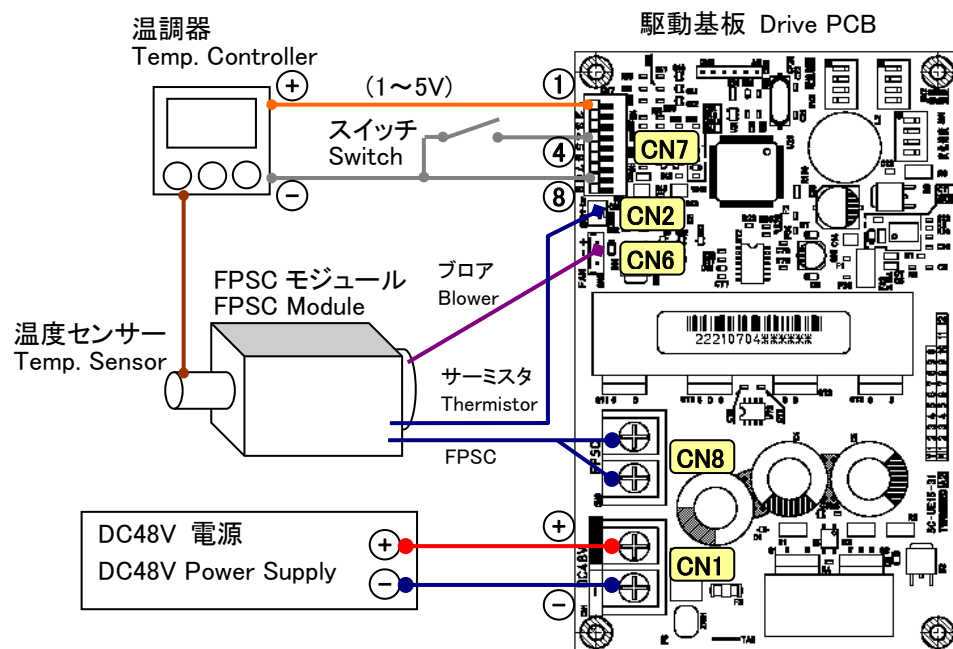

4. Basic Operation

4.1 Preparation

- (1) Power source: Voltage DC48V, Rating current: 5A
Prepare power supply output current more than 9A for peak current 9A.
- (2) Temp. controller and Temp. sensor
- (3) Wire and Switch

4.2 Start Procedure

- (1) Turn on the Switch of Power supply.
- (2) Turn on the Switch of the Drive PCB.

4.3 Stop Procedure

- (1) Turn off the Switch of the Drive PCB.
- (2) Turn off the Switch of Power supply.

[電流入力の場合 Current Input]

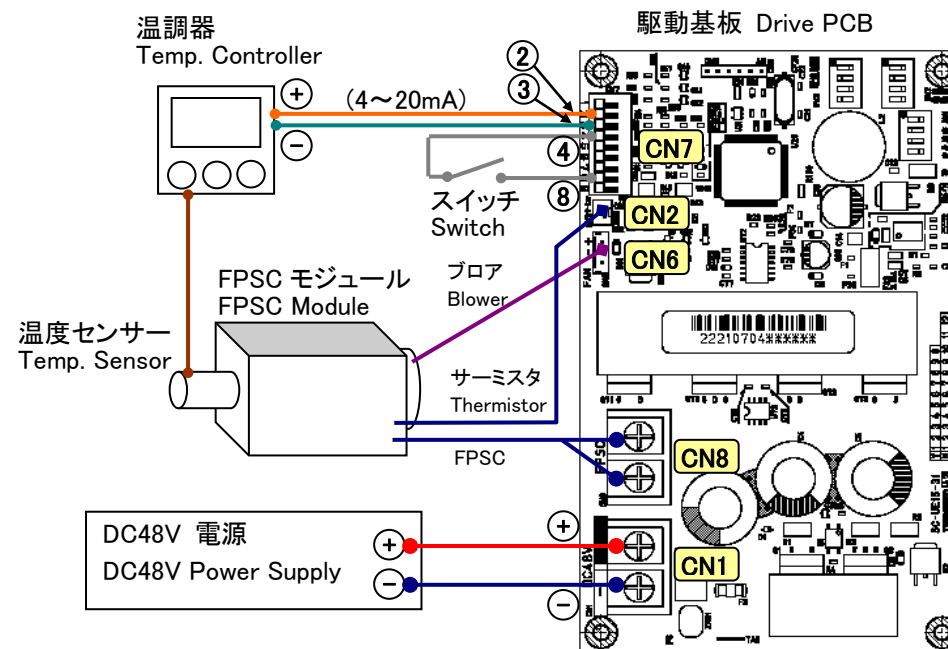

4.5 放熱

放熱フィンが埃等により目詰まりしないよう、フィルターを設置して目詰まりを防いだり、定期的に放熱フィンに付着した埃を取り去ったりします。放熱フィンが目詰まりすると放熱が不足して冷却能力の低下や故障の原因になります。

また、放熱、冷却能力向上のため、吸気はなるべく新鮮な空気を入れ、特に排気が回って来ないように、吸・排気経路の分離を行います。

4.6 断熱

吸熱部と排熱部の間で、温度が周囲より低くなる部分(断熱部)を断熱材で覆い、霜や露が着かないように断熱します。着霜や結露は冷却能力の低下につながり、融けた霜や露がリード線や内部の機構部品に流れ落ちると、電気回路がショートして故障したり、腐食の原因になったりします。

断熱部は、使用状況により、吸熱部のすぐ近くだけの場合と、放熱フィンの近くまでの場合があります。吸気を妨げないように注意します。

特に縦置き(吸熱部が上方)で使用する場合には冷却部を十分に断熱する等、結露水が冷凍機内に侵入しないよう願います。結露水が侵入すると、故障する場合があります。

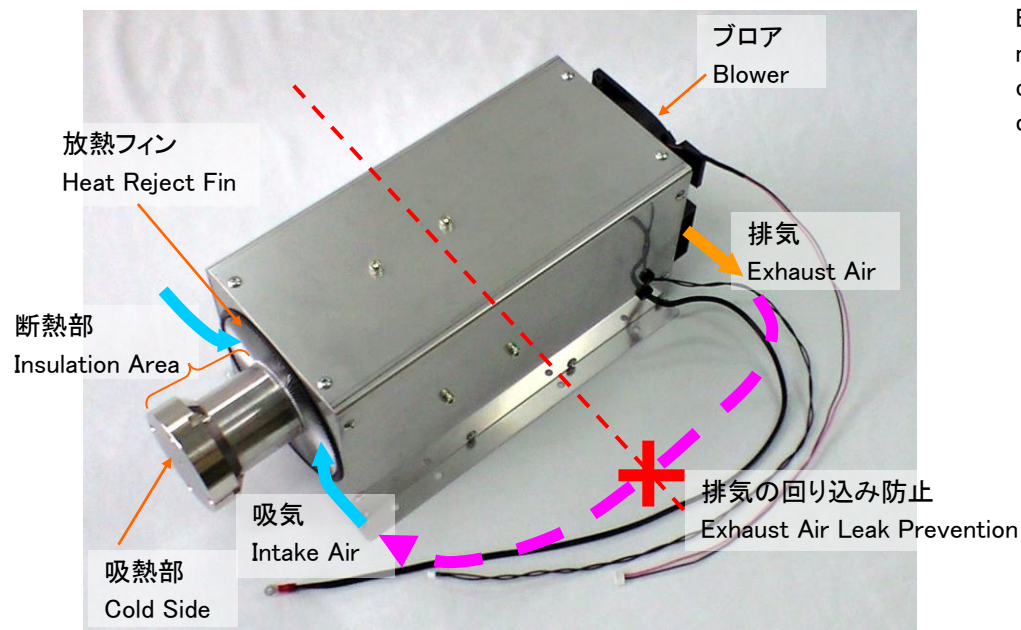

4.5 Heat Rejection

Provide with some air intake filters or remove dust regularly on the heat reject fin to prevent the heat reject fin from being filled by dust. The dust filling reduces heat rejection and cooling capacity and may cause damage of FPSC.

In order to have better heat rejection and cooling capacity, get fresh air for the intake. In particular, separate the intake duct and exhaust duct to prevent the exhaust air leakage to the intake.

4.6 Thermal Insulation

Cover with the insulation material over the area the temperature can be lower than ambient between the cold side and the warm side, which is called Insulation Area, to prevent having frost or condensation. Having frost or condensation on the Insulation Area can cause an apparent reduction of cooling capacity. Also, if water drips down on a read wire or inner mechanical parts as it defrosts, it could cause a short circuit or corrosion.

The Insulation Area may be closed to the cold side or up to near the heat reject fin depend on the operation condition. The insulation must not inhibit the intake airflow. Especially when using Stirling cooler vertically (with the cold side part facing up), make sure that the cooling part is well insulated so that condensed water dose not enter the Stirling cooler. If condensed water enters, it could cause internal damage.

5. 駆動基板の入出力

5.1 一覧

Pin	仕様	Pin	仕様	
[CN1]	吉田電機工業 PBX10C51-2 ・端子ねじ: M3.5 ・適正締付トルク: 0.8~1.2Nm	[CN7]	サトーパーツ ML-700-NV ・適合電線: 単線 ϕ 0.32~0.65mm (28~22 AWG) より線 0.08~0.32mm2 (28~22 AWG) (素線径 ϕ 0.12mm 以上) ・電線むき長さ: 9~10 mm	
1	+	電源入力		
2	-			
[CN2]	JST B2B-PH-K-E (青) ・適合コネクタ: JST PHR-2	1	出力設定入力 1	
1	排熱部サーミスタ	2	+	出力設定入力 2
2		3	-	
[CN6]	JST B3B-EH (白) ・適合コネクタ: JST EHR-3	4	運転/停止信号入力	
1	+	ブロー出力	5	異常信号出力
2	-		6	警告信号出力 1
3	空き(拘束センサー用)	7	警告信号出力 2	
[CN8]	吉田電機工業 PBX10C51-2 ・端子ねじ: M3.5 ・適正締付トルク: 0.8~1.2Nm	8	GND (信号側)	
1	FPSC 出力	9	DC5V	
2		[FG]	ϕ 1.8 mm (穴)	
[SW1]	DIP SW	-	GND (電源側)	
-	電圧変化速度設定			
[SW2]	DIP SW			
-	排熱部温度上限設定 1010: 70°C (この設定でご使用ください。)			
[SW3]	DIP SW			
-	電流制限値設定 1000: 7.6A (この設定でご使用ください。)			

5. Input and Output of Drive PCB

5.1 List

Pin	Specification	Pin	Specification	
[CN1]	YOSHIDA ELECTRIC INDUSTRY PBX10C51-2 - Screw: M3.5 - Proper Torque: 0.8~1.2Nm	[CN7]	SATO PARTS ML-700-NV -Acceptable Wire: Solid wire ϕ 0.32~0.65mm (28~22 AWG) Stranded wire 0.08~0.32mm2 (28~22 AWG) (Element wire ϕ 0.12mm Min) -Strip Length: 9 - 10 mm	
1	+	Power Source Input		
2	-			
[CN2]	JST B2B-PH-K-E (Blue) Acceptable Connector: JST PHR-2	1	Setting of Output 1	
1	Warm Side Thermistor	2	+	Setting of Output 2
2		3	-	
[CN6]	JST B3B-EH (White) Acceptable Connector: JST PHR-2	4	Drive / Stop of FPSC	
1	+	Output to Blower	5	Emergency Signal
2	-		6	Alarm Signal 1
3	NC	7	Alarm Signal 2	
[CN8]	YOSHIDA ELECTRIC INDUSTRY PBX10C51-2 - Screw: M3.5 - Proper Torque: 0.8~1.2Nm	8	GND (Signal Side)	
1	Output to FPSC	9	DC5V	
2		[FG]	ϕ 1.8 mm (Hole)	
		-	GND (Power Source Side)	
[SW1]	DIP SW			
-	Setting of Output Voltage Change			
[SW2]	DIP SW			
-	Setting of Warm Side Temperature Limit 1010: 70°C (Please use with this setting.)			
[SW3]	DIP SW			
-	Setting of Output Current Limit 1000: 7.6A (Please use with this setting.)			

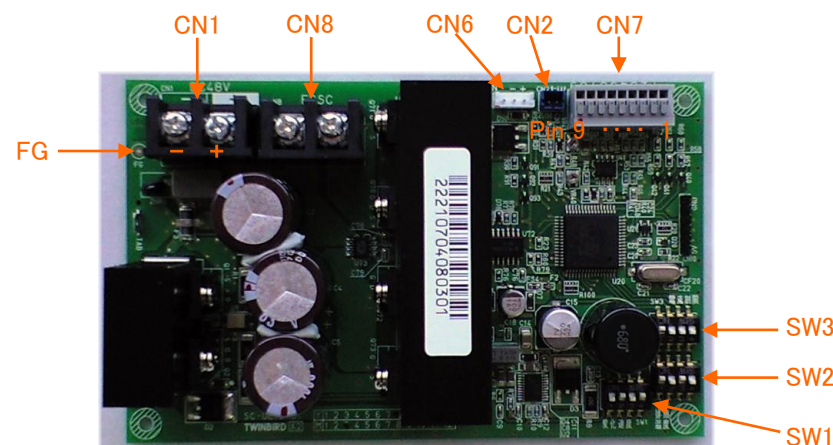

5.2 詳細

No.	仕様					
[CN1] 電源入力						
1	定格電圧	DC 48 V				
2	許容電圧範囲	DC 43.2 ~ 52.8 V (DC 48 V ± 10 %)				
3	定格電流	5A (48V 入力時)				
[CN6] ブロア出力						
1	出力条件	FPSC 駆動時				
2	出力電圧	DC 12 V ±10%				
3	最大出力電流	2 A				
[CN7] Pin1 出力設定入力 1 ^{*1}						
1	Step No.	入力有効範囲				
2	入力電圧[V] (CN7-Pin1)	0 ≤ V < 1	1	...	256	5 < V < 6
			4/255 (V/Step)			
3	出力電圧 [V] (CN8)	0	0	...	33.5	33.5
			33.5/255 (V/Step)			
入力回路  入力インピーダンス: 200 kΩ						
[CN7] Pin2,3 出力設定入力 2 ^{*1}						
1	Step No.	入力有効範囲				
2	入力電流[mA] (CN7-Pin2,3)	0 ≤ I < 4	4	...	20	20 < I < 21
			16/255 (mA/Step)			
3	出力電圧 [V] (CN8)	0	0	...	33.5	33.5
			33.5/255 (V/Step)			
入力回路  作動入力: 94 Ω						
*1 電圧および電流が同時入力されている場合は、電圧入力優先されます。						

5.2 Details

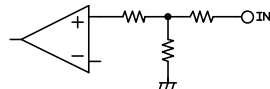
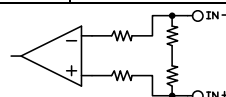
No.	Specification					
[CN1] Power Source Input						
1	Rating voltage	DC 48 V				
2	Allowable voltage	DC 43.2 ~ 52.8 V (DC 48 V ± 10 %)				
3	Rating current	5A (at 48V input)				
[CN6] Output to Blower						
1	Condition for output	While FPSC is driven				
2	Output voltage	DC 12 V ±10%				
3	Output current capacity	2 A				
[CN7] Pin1 Setting of Output 1 ^{*1}						
1	Step No.	Available Input Range				
2	Input Voltage [V] (CN7-Pin1)	0 ≤ V < 1	1	...	256	5 < V < 6
			4/255 (V/Step)			
3	Output Voltage [V] (CN8)	0	0	...	33.5	33.5
			33.5/255 (V/Step)			
Input Circuit  Impedance: 200 kΩ						
[CN7] Pin2,3 Setting of Output 2 ^{*1}						
1	Step No.	Available Input Range				
2	Input Current [mA] (CN7-Pin2,3)	0 ≤ I < 4	4	...	20	20 < I < 21
			16/255 (mA/Step)			
3	Output Voltage [V] (CN8)	0	0	...	33.5	33.5
			33.5/255 (V/Step)			
Input Circuit  Differential input impedance: 94 Ω						
*1 Input voltage has priority over input current.						

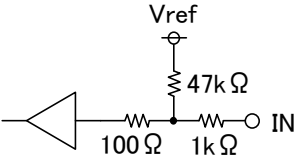
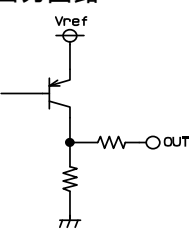

No.	仕様																												
[CN7] Pin4 運転/停止信号入力																													
1	High (DC5V) (Open)	停止																											
2	Low (GND)	運転																											
入力回路 																													
Vref: DC5V (±10%)																													
[CN7] Pin5 異常信号出力																													
1	High	異常 FPSC 及びブローアへの電圧出力を停止する。																											
2	Low	正常																											
※異常の条件 (1) 排熱側温度センサーの温度が、SW2 で設定された排熱側温度上限に達した。 (2) 排熱側温度センサーが接続されていないか、又は、断線した。 (3) 入力電源電圧が範囲外である。 ※異常信号出力停止条件 (1) 運転/停止信号が停止になった時																													
出力回路 																													
<table border="1"> <thead> <tr> <th>項目</th> <th>MIN.</th> <th>TYP.</th> <th>MAX.</th> <th>条件</th> </tr> </thead> <tbody> <tr> <td rowspan="2">出力電圧</td> <td>High</td> <td>Vref - 0.5V</td> <td>Vref</td> <td>-</td> <td>I=1mA</td> </tr> <tr> <td>Low</td> <td>-</td> <td>GND</td> <td>GND + 0.5V</td> <td>I=1mA</td> </tr> <tr> <td rowspan="2">出力電流</td> <td>High</td> <td>8mA</td> <td>10mA</td> <td>-</td> <td>V=4.5V</td> </tr> <tr> <td>Low</td> <td>-</td> <td>10 μA</td> <td>12 μA</td> <td>V=0.5V</td> </tr> </tbody> </table>			項目	MIN.	TYP.	MAX.	条件	出力電圧	High	Vref - 0.5V	Vref	-	I=1mA	Low	-	GND	GND + 0.5V	I=1mA	出力電流	High	8mA	10mA	-	V=4.5V	Low	-	10 μA	12 μA	V=0.5V
項目	MIN.	TYP.	MAX.	条件																									
出力電圧	High	Vref - 0.5V	Vref	-	I=1mA																								
	Low	-	GND	GND + 0.5V	I=1mA																								
出力電流	High	8mA	10mA	-	V=4.5V																								
	Low	-	10 μA	12 μA	V=0.5V																								
Vref: DC5V (±10%)																													

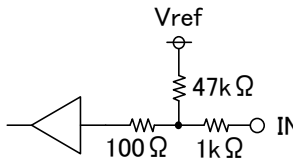
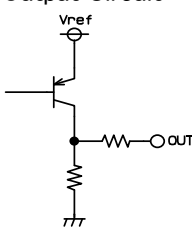
No.	Specification																												
[CN7] Pin4 Drive / stop of FPSC																													
1	High (DC5V) (Open)	Stop																											
2	Low (GND)	Drive																											
Input Circuit 																													
Vref: DC5V (±10%)																													
[CN7] Pin5 Emergency signal output																													
1	High	Emergency Power supply to the FPSC and the blower will be stopped.																											
2	Low	Normal																											
* Emergency situations (1) Temperature sensor at warm side has reached the limit temperature set by SW2. (2) Temperature sensor at warm side is disconnected or wire is cut. (3) The power source voltage is out of allowable range. *Condition for cancellation of the emergency signal output (1) When the on / off signal goes off																													
Output Circuit 																													
<table border="1"> <thead> <tr> <th>Item</th> <th>MIN.</th> <th>TYP.</th> <th>MAX.</th> <th>Condition</th> </tr> </thead> <tbody> <tr> <td rowspan="2">Output Voltage</td> <td>High</td> <td>Vref - 0.5V</td> <td>Vref</td> <td>-</td> <td>I=1mA</td> </tr> <tr> <td>Low</td> <td>-</td> <td>GND</td> <td>GND + 0.5V</td> <td>I=1mA</td> </tr> <tr> <td rowspan="2">Output Current</td> <td>High</td> <td>8mA</td> <td>10mA</td> <td>-</td> <td>V=4.5V</td> </tr> <tr> <td>Low</td> <td>-</td> <td>10 μA</td> <td>12 μA</td> <td>V=0.5V</td> </tr> </tbody> </table>			Item	MIN.	TYP.	MAX.	Condition	Output Voltage	High	Vref - 0.5V	Vref	-	I=1mA	Low	-	GND	GND + 0.5V	I=1mA	Output Current	High	8mA	10mA	-	V=4.5V	Low	-	10 μA	12 μA	V=0.5V
Item	MIN.	TYP.	MAX.	Condition																									
Output Voltage	High	Vref - 0.5V	Vref	-	I=1mA																								
	Low	-	GND	GND + 0.5V	I=1mA																								
Output Current	High	8mA	10mA	-	V=4.5V																								
	Low	-	10 μA	12 μA	V=0.5V																								
Vref: DC5V (±10%)																													



No.	仕様																								
[CN7] Pin6 警告信号出力 1																									
1	High	警告																							
2	Low	正常																							
※警告の条件 (1) 排熱部に設置した温度センサーの温度が、SW2 で設定された温度よりも 5°C低い温度に達した。 ※警告信号出力停止条件 (1) 警告の条件に該当しなくなった時。																									
[CN7] Pin7 警告信号出力 2																									
1	High	警告																							
2	Low	正常																							
※警告の条件 (1) FPSC への出力設定信号のレベルが規定の範囲外である。 ※警告信号出力停止条件 (1) 警告の条件に該当しなくなった時。																									
警告信号 1 及び警告信号 2 の出力回路																									
<table border="1"> <thead> <tr> <th>項目</th> <th>MIN.</th> <th>TYP.</th> <th>MAX.</th> <th>条件</th> </tr> </thead> <tbody> <tr> <td rowspan="2">出力電圧</td> <td>High</td> <td>Vref - 0.5V</td> <td>Vref</td> <td>-</td> </tr> <tr> <td>Low</td> <td>-</td> <td>GND</td> <td>GND + 0.5V</td> </tr> <tr> <td rowspan="2">出力電流</td> <td>High</td> <td>8mA</td> <td>10mA</td> <td>-</td> </tr> <tr> <td>Low</td> <td>-</td> <td>10 μA</td> <td>12 μA</td> </tr> </tbody> </table>			項目	MIN.	TYP.	MAX.	条件	出力電圧	High	Vref - 0.5V	Vref	-	Low	-	GND	GND + 0.5V	出力電流	High	8mA	10mA	-	Low	-	10 μA	12 μA
項目	MIN.	TYP.	MAX.	条件																					
出力電圧	High	Vref - 0.5V	Vref	-																					
	Low	-	GND	GND + 0.5V																					
出力電流	High	8mA	10mA	-																					
	Low	-	10 μA	12 μA																					
Vref: DC5V (±10%)																									
[CN8] FPSC への出力																									
1	駆動波形	PWM 波形																							
2	基本周波数	80.0 Hz																							
3	キャリア周波数	28.8 kHz																							
4	出力電圧範囲	AC 0~33.5 V (RMS) at 80.0Hz																							
5	最大出力電流	9A (RMS)																							

No.	Specification																								
[CN7] Pin6 Alarm signal 1																									
1	High	Alarm																							
2	Low	Normal																							
* Situation for alarm signal 1 output (1) The temperature of the sensor on the warm side reaches 5 deg C lower than the temperature set by SW2. *Condition for cancellation of the emergency signal output (1) When the temperature of the sensor on the warm side goes down 5 deg C lower than the temperature set by SW1.																									
[CN7] Pin7 Alarm signal 2																									
1	High	Alarm																							
2	Low	Normal																							
* Situation for alarm signal 1 output (1) The level of output set signal is out of the allowed range. *Condition for cancellation of the emergency signal output (1) When the level of output set signal is within the allowable range.																									
Output Circuit of Alarm signal 1 and Alarm signal 2																									
<table border="1"> <thead> <tr> <th>Item</th> <th>MIN.</th> <th>TYP.</th> <th>MAX.</th> <th>Condition</th> </tr> </thead> <tbody> <tr> <td rowspan="2">Output Voltage</td> <td>High</td> <td>Vref - 0.5V</td> <td>Vref</td> <td>-</td> </tr> <tr> <td>Low</td> <td>-</td> <td>GND</td> <td>GND + 0.5V</td> </tr> <tr> <td rowspan="2">Output Current</td> <td>High</td> <td>8mA</td> <td>10mA</td> <td>-</td> </tr> <tr> <td>Low</td> <td>-</td> <td>10 μA</td> <td>12 μA</td> </tr> </tbody> </table>			Item	MIN.	TYP.	MAX.	Condition	Output Voltage	High	Vref - 0.5V	Vref	-	Low	-	GND	GND + 0.5V	Output Current	High	8mA	10mA	-	Low	-	10 μA	12 μA
Item	MIN.	TYP.	MAX.	Condition																					
Output Voltage	High	Vref - 0.5V	Vref	-																					
	Low	-	GND	GND + 0.5V																					
Output Current	High	8mA	10mA	-																					
	Low	-	10 μA	12 μA																					
Vref: DC5V (±10%)																									
[CN8] Output to FPSC																									
1	Drive wave shape	PWM																							
2	Frequency	80.0 Hz																							
3	Carrier frequency	28.8 kHz																							
4	Output voltage range	AC 0~33.5 V (RMS) at 80.0Hz																							
5	Output current capacity	9A (RMS)																							



No.	仕様				
[SW1] 電圧変化速度設定 ^{※3}					
SW1 ^{※1}	電圧変化速度	上昇時間 ^{※2}	SW1	電圧変化速度	上昇時間
0101	1 step /2.4 sec	10min12sec	1011	1 step /8.0 sec	34min00sec
0110	1 step /3.2 sec	13min36sec	1100	1 step /10.4 sec	44min12sec
0111	1 step /4.0 sec	17min00sec	1101	1 step /12.8 sec	54min24sec
1000	1 step /4.8 sec	20min24sec	1110	1 step /16.0 sec	1h08min00sec
1001	1 step /5.6 sec	23min48sec	1111	1 step /19.2 sec	1h21min36sec
1010	1 step /6.4 sec	27min12sec	-	-	-
<p>※1 [0101] 以上の設定でご使用ください。 スターリングクーラーは、大きな熱負荷を冷却する場合、あるいは大きな熱変動を伴う場合、異常振動による異音が発生し、故障に至る恐れがあります。 ご使用において、異音が発生した場合は、次ページの「<u>ご使用にあたってのお願い</u>」を参照して、駆動設定の変更をお願い致します。</p> <p>※2 0V から 33.5V に達するまでの時間。 ※3 運転停止時の電圧変化速度: 10 step / 0.13 sec</p>					
[SW2] 排熱部温度上限設定					
1010	70°C				
この設定でご使用ください。設定を変更して使用した場合、故障の原因となります。					
[SW3] 電流制限値設定					
1000	7.6A				
この設定でご使用ください。設定を変更して使用した場合、故障の原因となります。					

No.	Specification				
[SW1] Setting of Output Voltage Change ^{*3}					
SW ^{*1}	Change speed of output voltage	Ramp time ^{*2}	SW1	Change speed of output voltage	Ramp time
0101	1 step /2.4 sec	10min12sec	1011	1 step /8.0 sec	34min00sec
0110	1 step /3.2 sec	13min36sec	1100	1 step /10.4 sec	44min12sec
0111	1 step /4.0 sec	17min00sec	1101	1 step /12.8 sec	54min24sec
1000	1 step /4.8 sec	20min24sec	1110	1 step /16.0 sec	1h08min00sec
1001	1 step /5.6 sec	23min48sec	1111	1 step /19.2 sec	1h21min36sec
1010	1 step /6.4 sec	27min12sec	-	-	-
<p>*1 Select [0101] or bigger. Stirling Cooler may operate with rather larger noise and /or vibration when your cooling object has larger heat mass or heat fluctuation in some cases. This operation in such condition also causes irreversible damage to your Stirling Cooler. Refer to “CAUTION” on next page and set optimum configuration on circuit board when Stirling cooler operates with larger noise or larger vibration.</p> <p>*2 The time from 0V to 33.5V *3 Change speed of output voltage is fixed in process for stop: 10 step / 0.13 sec</p>					
[SW2] Setting of Warm Side Temperature Limit					
1010	70 deg. C				
Please use with this setting. Changing this setting could cause internal damage.					
[SW3] Setting of Output Current Limit					
1000	7.6A				
Please use with this setting. Changing this setting could cause internal damage.					

6. お問い合わせ先

ツインバード工業株式会社
 SC 営業部
 Tel: 03-3663-8774
 Fax: 03-3663-8642
 〒103-0001 東京都中央区日本橋小伝馬町 14-4 ツインバード日本橋ゲートオフィス

6. Contact

TWINBIRD CORPORATION
 SC Sales Department
 Phone: +81-3-3663-8774
 Facsimile: +81-3-3663-8642
 Address: 14-4, Kodenma-cho, Nihonbashi, Chuo-ku, Tokyo, 103-0001, Japan



ご使用にあたってのお願い

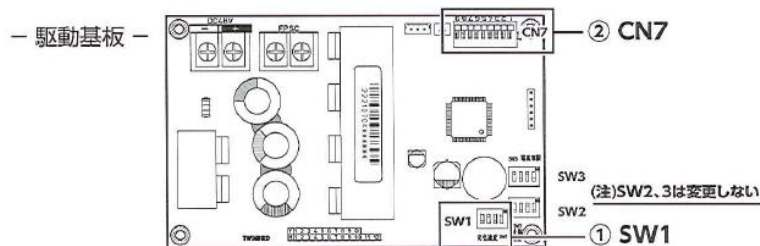

(1) 運転開始～出力設定電圧までの間に異音が発生した場合

駆動基板 SW1「電圧上昇速度設定」を変更して、出力電圧の変化速度を遅くしてください。

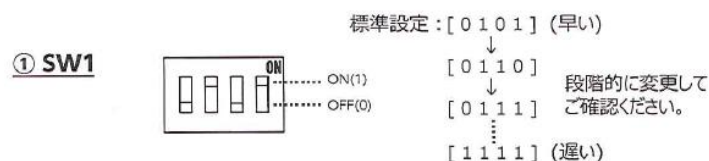

(2) 出力設定電圧に安定した状態で異音が発生した場合

以下の方法で「出力設定入力」を下げて、出力電圧を抑えて下さい。

電圧制御の場合

1番ピンの印加電圧を下げる

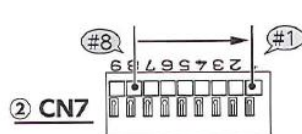

電流制御の場合

2番ピンから3番ピンへの電流を下げる

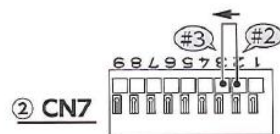

CAUTION

— Circuit Board —

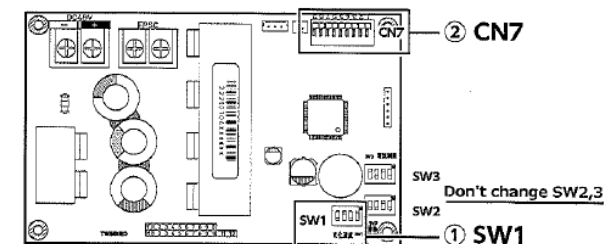

(1) Change SW1 to make slower as shown below when Stirling Cooler operates with some noise and/or vibration during starting up procedure.

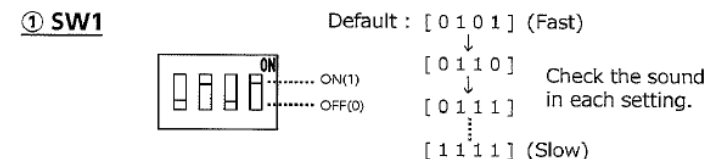

(2) Decrease CN7 "Setting of Output" to lower as shown below when such noise and/or vibration is generated after operation voltage reached to stable value.

Voltage control

Decrease applied voltage to Pin#1

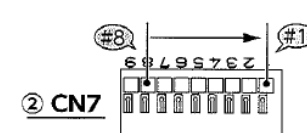

Current control

Decrease current from Pin#2 to Pin#3

